



Instructions for Use and Maintenance

Snow Blower 2450HD -2452HD



Note!
Read instructions before use

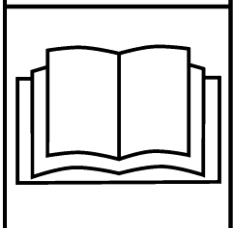

TREJON FÖRSÄLJNINGS AB
Företagsvägen 9
SE-911 35 VÄNNÄSBY
SWEDEN
Tel: + 46 (0)935 39 900
Webb: trejon.se



■ TABLE OF CONTENT

1	Introduction	7
1.1	Foreword	7
1.2	Description	7
1.3	Working stages.....	7
1.4	Detailed description.....	8
1.5	Technical data	9
2	Safety instructions	10
2.1	Safety directions.....	10
2.2	Explanation of the symbols	13
3	Using the equipment.....	15
3.1	Assembly.....	15
3.2	Attaching machine to the tractor.....	16
3.3	Before starting up	18
3.4	Adjustments.....	18
3.5	Operating the machine	20
4	Service and maintenance	22
4.1	General.....	22
4.2	Maintenance schedule	23
4.3	Before the snowy season	24
4.4	After the snowy season	24
4.5	Gearbox oil check and change	24
5	Troubleshooting	25
6	Spare Parts	26
	EC-Certificate of Conformity	28

SAFETY SYMBOLS

Note! This warning symbol is used throughout this instruction manual to call attention to safety precautions that you, your employees or any other people that may come near the implement must read and understand. Failure to follow these instructions may result in serious injury or even death.

This symbol means:



WARNING!
CAUTION!
YOUR SAFETY IS
ENDANGERED!

A word of advice

Pay special attention to the words **WARNING!**, **CAUTION!** and **NOTE!** in the safety instructions. The words have been chosen from of the following:



WARNING! This safety sign is used to identify potential hazards that can lead to serious injury or even death. These hazards include situations that may occur when the safety equipment and/or the safety shields are removed. Signal words can also be used to alert about dangerous use.



CAUTION! Failure to observe this warning sign could result in light personal injuries. The sign is also used to indicate that the disregarding of these instructions may cause damage to the implement.

Dear Customer,

You have made a good choice. We congratulate you to your selection of an OPTIMAL product that offers quality and performance with reliable service.

By reading the manual and following its recommendations you will ensure the long and effective use of the equipment.

We have produced this manual for you to get a good understanding of the functioning of the machine and what safety and maintenance instructions to follow when working with it.

If any question should arise when using the machine or when reading this manual, you are welcome to contact us for further information.

TREJON AB
Företagsvägen 9
SE-911 35 Vännäsby
Sweden

Tel: + 46 (0)935 399 00

Email: info@trejon.se

Website: www.trejon.se

Honoured retailer,

in order for the guarantee to be valid and to fulfill all legal requirements, we ask you to fill out the guarantee form together with the customer and register at trejon.se

The guarantee is valid from the day the equipment is handed over to the customer.

Delivery checklist:



Check for damages caused in transporting. Inform the transporting company.	
Check that all packing material has been taken away. Dispose packing material in an environmentally friendly way	
Check if the PTO-shaft with shear bolt 3600Nm is included.	
Check that the machine is lubricated, see section "Service and maintenance".	
Check that all screws are properly tightened, see section "Service and maintenance".	
Check that all guards and safety shields are properly fastened.	
Check the oil level in the gearbox. See section "Service and maintenance".	
Check chain tension, see section "Service and maintenance"	
Make a function test.	
Having gone through and explained to the customer, with the help of the manual, the startup, use and maintenance of the equipment and its accessories.	
Fill out the guarantee form with the customer and register at trejon.se	
Instruction manual given to the customer.	

Enter the serialnumber of the machine to the right.	S/N:
---	------

1 Introduction

1.1 Foreword

Thank you for choosing this OPTIMAL machine. We have concentrated our efforts in order to develop a sturdy machine that will operate trouble-free for many years. The working life of the machine, however, depends not only on us but also on you. We have compiled this instruction manual in order to facilitate the use of the implement and describe proper maintenance procedures. Read these instructions carefully. Contact the retailer from whom you purchased the machine whenever you want to order repair parts or need any other assistance. When you are ordering repair parts, make sure that you know the right model, type and serial number. See the identification plate on the chassis.

1.2 Description

The equipment is designed to clear snow from level ground such as roads and parking lots. The snow blower is to be mounted at the front or at the rear on the three point lift of the tractor. Cat. II/III. A double acting hydraulic connection is needed to turn the ejector tube. If the equipment is fitted with an hydraulic flap regulator, an added double acting connection is needed. The equipment is powered by the PTO of the tractor. When mounted to the rear of an pulling tractor: 540 rpm (not 2452HD). When mounted on a reversing tractor: 540 rpm. When mounted to the front of a tractor: 1000 rpm on a highly mounted axle shaft.

1.3 Working stages

The equipment works in three stages:

1. Break-up and feeding in with self-cleaning feed screws with cutting action.
2. Transport to the ejecting rotor.
3. The ejecting rotor will powerfully throw out the snow through the ejector tube. The ejector tube is adjustable as to the direction and the distance of the thrown snow.

1.4 Detailed description

1	Chassie
2	Ejector tube (long or short tube)
3	Twinflap
4	Ejecting rotor
5	Feeder screw (model 2452 HD with two screws)
6	Flap control
7	Turntable gear
8	Reversible wearing edge
9	Gearbox
10	Drive shaft for frontal mounting, 1000 rpm
11	Drive shaft for rear mounting, 540 rpm
12	Drive shaft for rear mounting on a pulling tractor, 540 rpm
13	Shear bolt clutch for the feeder screw
14	Tool box with holders for spare shear bolts
15	3-point mounted, adjustable, bolted pulling frame
16	Width extender (optional)

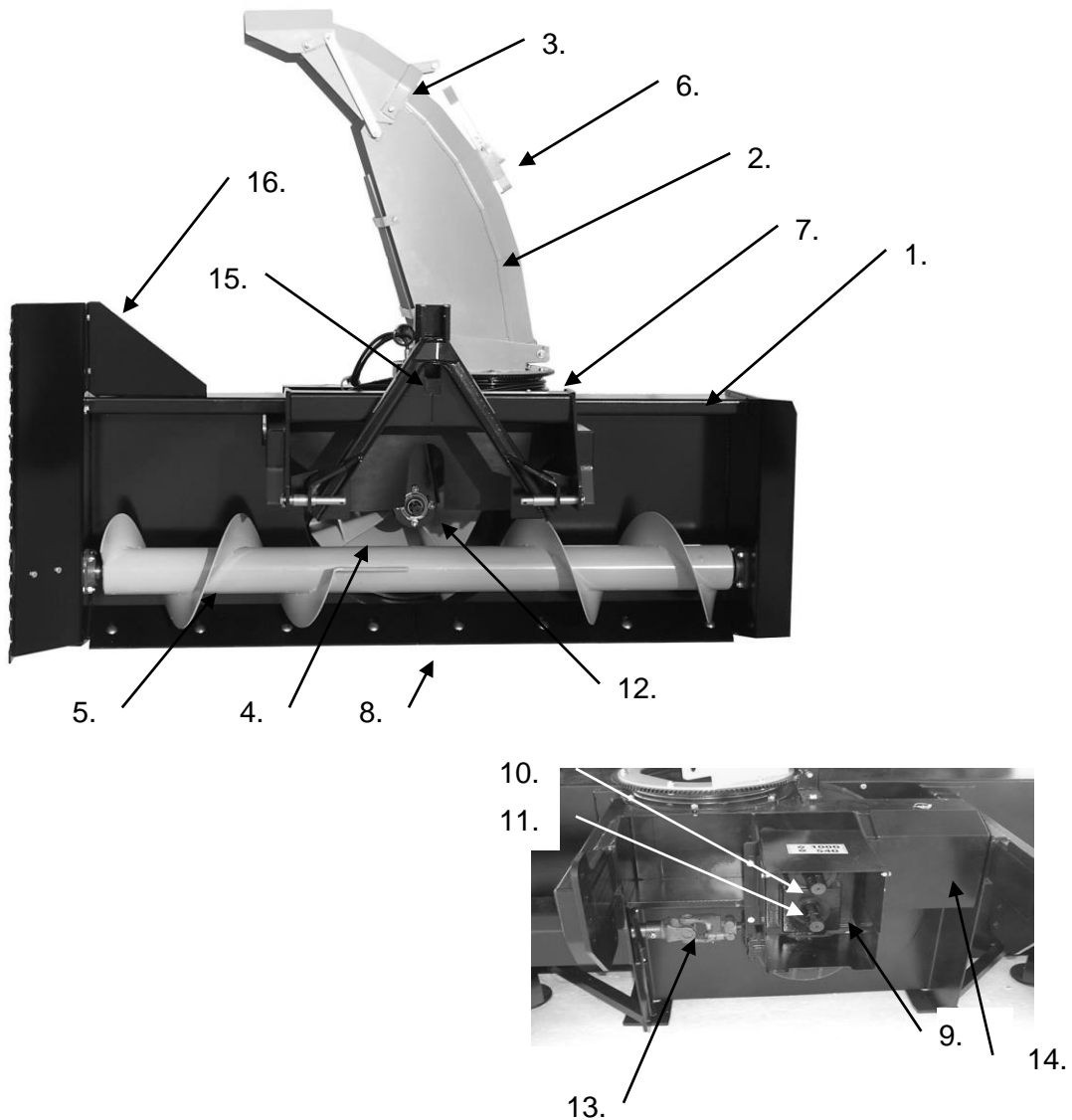

1.5 Technical data

Technical data / model	2450HD	2452HD
Working width (mm)	2430	2430
Frame height (mm)	960	960
Cutting auger, units	1	2
Cutting auger, diameter (mm)	440	1 x 440 + 1 x 340
Ejecting rotor, diameter (mm)	800	800
Recommended tractorpower (hp)	100-200	100-200
Rotating ejector tube, standard	Hydraulic	Hydraulic
Flap control, standard	Mechanical	Mechanical
Weight, basic unit (kg)	1000	1100
PTO operational rpm	540/1000	540/1000
Attachment to tractor	3-point	3-point
Mounting variations	F - P - R	F – R

Due to continuous product development, any data is subject to change without prior notice.

F=Front mounted: 1000 rpm, P=Pulled: 540 rpm, R=Reversing: 540 rpm.

2 Safety instructions



2.1 Safety directions

Read operator's manual. All drivers of the machine must read and understand all the contents of this operator's manual, so there is no doubt about management before using the equipment for the first time. If any hesitation, ask your Trejon dealer about advise. It is forbidden to use the equipment if user don't know the risk factors at handling, and don't know how to act in an emergency situation.

Read, observe and understand meaning of all safety-, use-, warning- and position- symbols at machine and in user manual.

Safety is the primary concern in the design and manufacture of our products. Unfortunately our efforts to provide safe equipment can be wiped out by a single careless act of an operator. In addition to the design and configuration of equipment, hazard control and accident prevention are dependent upon the awareness, concern, prudence and proper training of personnel involved in the operation, transport, maintenance and storage of equipment. Allow only properly trained personnel to operate the equipment.

The machine is intended only for outdoor use.

Management. Learn how to operate the machine and how to use the controls properly before operating the machine.

Connect the machine. Attach the machine correctly; don't stand behind the tractor during installation. Ensure machine is properly mounted, adjusted and in good operating condition. Failure to ensure a secure coupling of the implement to the tractor can cause injury and damage to the implement or tractor.

Secure the working area. Unauthorized persons, particularly children, are not allowed near the machine while it is running or is being repaired. Before backing up, look behind carefully.

Pay attention to the injury and damage that can be caused by material thrown by machine during operating, therefore clear area of stones, branches or other debris that might be thrown, causing injury or damage. Take care never to aim the snow outlet towards people, animals or buildings.

The rotating parts of this machine have been designed and tested for rugged use. However, they could fail upon impact with heavy, solid objects such as steel guard rails and concrete abutments. Such impact could cause the broken objects to be thrown outward at very high velocities. To reduce the possibility of property damage, serious injury, or even death, never allow the cutting blades to contact such obstacles.

Machines protective equipment. Do not operate the machine if not all safety guards and shields for moving parts are in place and in good condition. Ensure that all safety and operating signs are in good condition. Additional safety and operating decals are available at no extra charge. Please specify model and serial number when ordering.

Moving parts. Keep hands, feet, hair and clothing away from moving parts of the machine. Let the machine work by it self, don't try to help the machine with hands and fingers.

PTO-shaft. When changing tractor always check the length of the PTO-shaft, a too long shaft can damage both tractor and machine. It is forbidden to use PTO-shaft that does not fulfil requirements from manufacture.

Make sure that PTO-shields are in good condition and fastened securely to the tractor. It is forbidden to use a PTO-shaft with damaged or missing shield. Purchase a new shield if old shield is damaged or missing.

Lifting and lowering machine. Be careful when lifting or lowering the machine.

Stability. The machine should not be mounted on a tractor with insufficient front shaft /back shaft weight when the tractor becomes unstable and difficult to operate. When using a unit, a minimum 20% of tractor and equipment weight must be on tractor front wheels. Without this weight, tractor could tip over, causing personal injury or death. The weight may be attained with a front end loader, front wheel weights, and ballast in tires or front tractor weights, read the tractor's instructions manual for more information.

In extremely uneven terrain rear wheel weights, front tractor weights, and/or tire ballast should be used to improve stability.

Operating machine. Be careful and reduce the speed when working on uneven surfaces. Watch for holes, roots, rocks or other hidden objects. Do not drive near the edge of a gully, ditch or stream bank. When mowing over uneven terrain, observe the type of terrain and develop a safe mowing pattern.

When driving in slopes:

Operate the machine up and down steep slopes, not across slopes, to prevent the tractor from tipping. Avoid sudden stops and starts, slow down before changing directions on a slope. Pass diagonally through sharp dips and avoid sharp drops to prevent hanging up the tractor and machine. If tractor overturns, hold tight to steering wheel.

Operating in darkness. When working in the dark hours, make sure there is sufficient lighting in the working area.

Driver. Do not operate the equipment when you are tired, sick or when using medication. Only properly trained people with driver's license is allowed to operate this machine. Do not allow riders on the machine or tractor at any time. There is no safe place for riders.

Personal protective equipment. Personal protection equipment including hard hat, safety glasses, safety shoes, and gloves are recommended during assembly, installation, adjustment, maintaining and/or repairing the implement. Avoid loose fitting clothing which can become entangled. Wear sturdy, tough-soled work shoes and protective equipment for eyes, hands, ears and head.

Safety cabin. Operate the machine only with a tractor equipped with an approved Roll-Over-Protective-System (ROPS). Keep doors at tractors cabin closed during operating, serious injury or even death could result from falling off the tractor.

Daily maintenance. Inspect the entire machine periodically. Look for loose fasteners, worn or broken parts, and leaky or loose fittings. Periodically tighten all bolts, nuts and screws and check that all cotter pins are properly installed to ensure unit is in a safe condition.

No wrappings or foreign objects are around the machine.

Frequently check mower blades. They should be sharp, free of nicks and cracks and securely fastened.

Safety during maintenance and repairing. Apply hand brake and place the machine on a hard level surface when maintaining or adjusting it. Always stop the tractor, set brake, shut off the tractor engine, remove the ignition key, and allow machines moving parts to come to a complete stop before dismounting tractor. Ensure that all moving parts have stopped completely before making adjustments, servicing or cleaning the machine. If the machine has been raised for cleaning, maintenance, inspection or repairs, it is imperative that you prevent it from sinking or falling down by placing supports under the machine. Never work under equipment unless it is blocked securely. Keep service area clean and dry. After servicing, be sure all tools, parts and service equipment are removed. Clean the machine thoroughly before repairs or storage. Be sure to thoroughly wash the machine without using excessive pressure especially on the moving parts, bearings and electric components. After cleaning, carefully dry the machine and lubricate it and perform a short test drive.

Vibrations. Do not use the machine if it is vibrating or shaking. Stop and investigate the cause. Change any damaged parts.

Emergency stop. Know how to stop the tractor and machine quickly in case of an emergency. After striking an obstacle, shut the tractor down and thoroughly inspect for damage before restarting.

Hydraulic hoses. The machine's hydraulic hoses contain oil under high pressure. Never touch the hoses or other hydraulic components while there is still pressure in the system. In case of leakage, oil under high pressure can penetrate the skin and cause serious injuries. If accident happen, contact doctor.

Check the condition of the hydraulic hoses every day. Worn or leaking hoses must be replaced immediately with new hoses that meet the manufacturer's technical requirements. The hydraulic motor and the hoses become hot during work; there is a risk for burn injury. Never loosen the hoses while the oil is still hot. Wait until it cools down. When changing tractor, check length of hydraulic hoses, if too long or short, they can easily be damaged.

Welding. Protect bearings, electronic and hydraulic components before any welding is done. Place earth connection close to the place for welding.

Fire danger. If any component gets over heated, stop machine and check reason. There is an increased risk of fire when working in dry areas.

Spare parts. Use only original repair parts

Where replacement parts are necessary for periodic maintenance and servicing, genuine replacement parts must be used to restore your equipment to original specifications. The company will not claim responsibility for use of unapproved parts and/or accessories and other damages as a result of their use.

Unauthorized modifications to the machine may impair the function and/or safety of the machine and reduce its life. If equipment has been altered in any way from original design, the manufacturer does not accept any liability for injury or warranty.

2.2 Explanation of the symbols

The warning symbol must always be recognizable. If the warning symbols are missing from your equipment or if they are damaged, replace them at once.

The symbol to the right shows:



Warning!

Read and follow the manual and the safety instructions before using the equipment. Pass on all safety instructions to other users of the equipment.



Warning!

Do not touch moving parts. Do not move about near the PTO when the equipment is operating.



Warning!

Matter such as stones and clumps of ice may fly away when the equipment is being used. The operator must pay attention to where the snow is blown, and should avoid working where people, animals and buildings are. Maintain the safety distance.





Warning!

Do not touch the feed blades or the feed screws as long as the tractor's engine is running and the PTO shaft is engaged. Maintain the safety distance.



Warning!

Crushing hazard! When connecting, never stand between the tractor and the equipment as long as the tractor is moving. The tractor must be immobilized with the parking brake whenever the operator leaves the cabin.



Warning!

Crushing hazard! When the ejector tube is lowered the engine of the tractor and the PTO must be switched off. Never use your arms or your legs to clear the ejector tube.



The CE symbol mounted by the manufacturer confirms that the equipment altogether meets all requirements concerning machinery directives and other corresponding EG directives.

The serial number and model is stamped on the identifying plate (see the picture).

		TREJON AB Företagsvägen 9 SE- 911 35 VÄNNÄSBY SWEDEN www.trejon.se		
		Model	<input type="text"/>	
Serial No.	<input type="text"/>	Prod. Year	<input type="text" value="20"/>	
Weight	<input type="text"/> kg	Total Weight	<input type="text"/> kg	

3 Using the equipment

3.1 Assembly



Caution!

No persons is allowed to be in danger area during lifting

Be carefully when cutting bands and wire because they can be very tensed. They can also be very sharp.

Following steps will be performed during the assembling:

Take away all packing and wrapping material, and discard it in an environmentally friendly way.

Assemble the ejector pipe and tighten the bolts.

The 3-point connection frame is bolted to the machine. When delivered, the equipment is fitted for towed operation (Not valid for 2452HD). If the equipment is to be used on the front of the tractor or on a reversing machine, the connection frame must be moved.

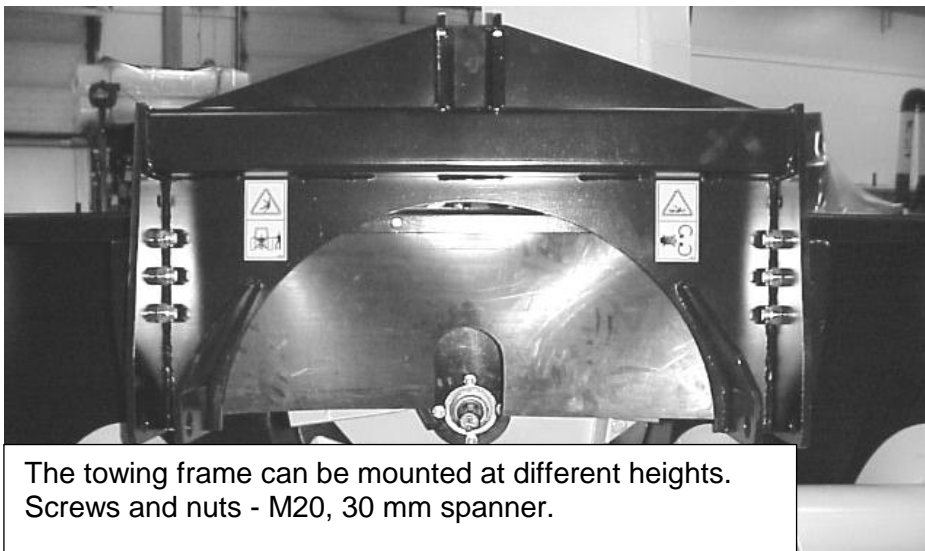

The towing frame can be mounted at different heights. The towing frame can be adjusted according to the tractor to which it is attached. Adjust the height so that you can lift the equipment off the ground and at the same time being able to lower it when working.



If the equipment is mounted on the front, or is to be used on a reversing machine, one should strive to mount the towing frame so low that the lifting arms of the tractor steers the equipment as low as possible. This insures that the equipment goes over obstacles as smoothly as possible.

Check that all protective devices are undamaged and correctly attached to the equipment. Before operating the machine, tasks in section 3.3 – “Before starting up” must be cleared.

3.2 Attaching machine to the tractor



Warning!

Crushing hazard! When connecting, never stand between the tractor and the equipment as long as the tractor is moving. Always immobilize the tractor when leaving the cabin for any coupling/decoupling work.

The machine should not be mounted on a tractor with insufficient front shaft weight, when the tractor becomes unstable and difficult to operate. If necessary use attain ballast weights, read the tractor’s instructions manual for more information.

Only use original PTO-shaft. Read carefully instructions attached at PTO-shaft. Information in this snow blower instruction manual doesn’t replace information from PTO-shaft manufacturer.



Caution!

Check that rpm-speed and direction at tractors PTO, agree with signs and symbols at machine.

Attach the machine at a hard level surface.

Attach tractors lifting arms to lower connection points at machine, and there after the top link, (choose connection points that make lifting arms and top link as parallel as possible, all to make machine levelled during lifting)

Turn of tractor's engine and apply the hand brake.

Adjust the length of the PTO shaft. Pull the shaft apart, and fit the end with the shear pin and mounting flange on to the tractor. Check that the shaft does not bottom out in any position, (min. play 30mm) and that the sliding part is sufficiently seated in the cuff part (min. 300 mm)*. If not, shorten the shaft. See the instructions that came with the shaft, (trim any cutting edges of , to avoid damages on pipes when telescoping). Try to attain longest possible shaft overlap. Be extra careful with shaft overlap when using hydraulic top link, when this equipment can make quick changes at measure. Note that usually the shaft is shorter when mounting at the front than when mounting at the rear.

*Alternative for PTO-shafts shorter than 1000mm, use at least half of maximum overlap.

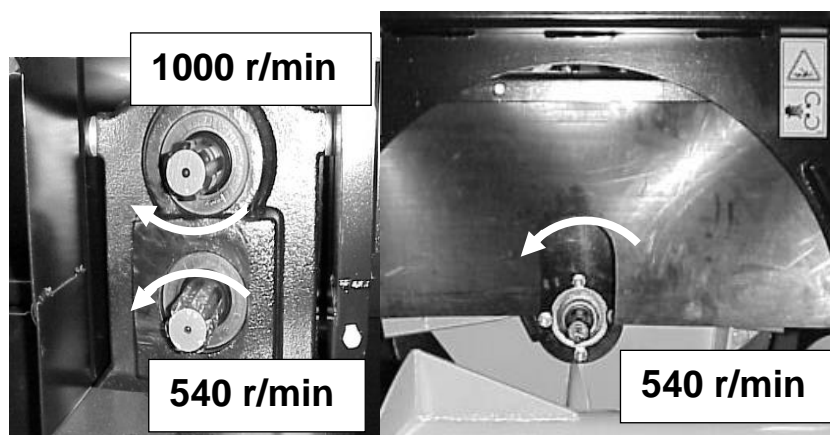

Duty rpm's and rotational directions for drive shafts 1-3/4" Z6

When used on a reversing tractor and when mounted on the front, the shear bolt clutch must always be closest to the tractor. A wrongly mounted PTO shaft can result in a breakage of the drive shaft.

Use the chains to fasten the PTO-shaft guards, so they don't rotate.

Lock lifting arms sideways with the stabilizer rods.

Attach hydraulic hoses for ejecting pipe control to double acting outlets at tractor. Clean the connections carefully before attaching. Before using the equipment, test the operation of the ejector pipe control.

Check that machine can work freely from tractor in all predictable situations.

3.3 Before starting up

Before starting up, following items must be checked.

Check the screws and bolts at the machine and tighten if necessary. See table with recommended torque settings in section "Service and maintenance":

Check that all protective devices are undamaged and correctly attached to the equipment.

Lubricate the machine (see section "Service and maintenance").

Check the oil level in the gearbox. The oil should reach the lower plug at the side of the gearbox. The gearbox is filled with SAE 80W/90 API GL4/GL5 (ISO VG 220) gear oil.

Adjust height of scraper steel with support pads, and machine tilt with top link (see section "Adjustments")

Check that no objects have wrapped themselves around moving parts.

Perform a trial run of entire machine.

3.4 Adjustments



Warning!

No work is allowed unless the equipment is safely secured (don't completely rely on tractors 3-point connection).

Be careful when undoing the pierced rod of flap control, crushing hazard!

At any time when performing repairs and maintenance, the engine must be switched off and the PTO shaft disconnected. Withdraw the ignition key from the switch.

Support pads

The height of the equipment is adjusted with two supporting pads located at the back. The angle of the equipment is adjusted with the top-link. This determines how well the equipment follows the variations in the surface. If the equipment is angled forward, it is easier for it to cut through packed snow and ice. A suitable basic adjustment when the machine rests on the support pads, is that the wearing edge of the scraper steel is 10mm above ground. Aim at keeping the machine levelled during work.

The supporting pads are to be adjusted as the wearing edge is being worn down. The supporting pads are adjusted by undoing the mounting screws, and mount them in other holes.

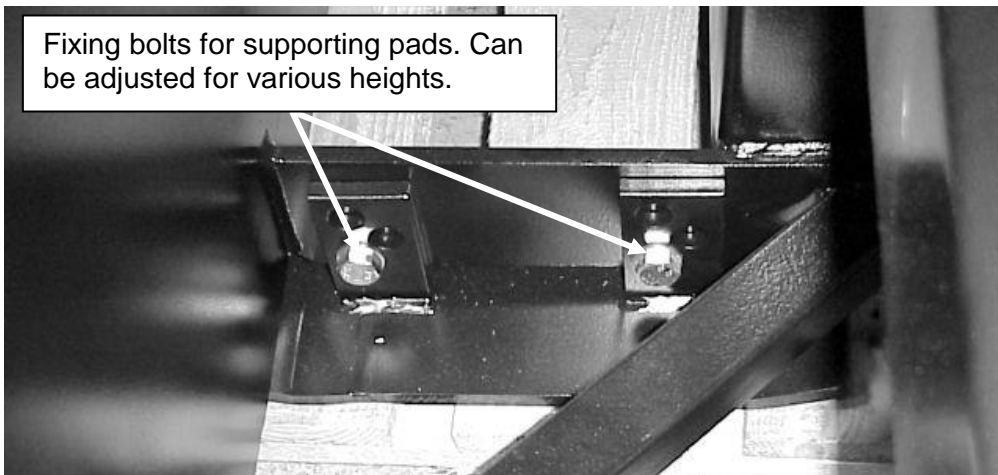

Ejector tube

The equipment comes fitted with a hydraulically turntable ejector tube as standard. At the end of the tube is a flap that regulates the distance the snow is thrown. Turn up the handle that locks the pierced rod, move the rod to the desired position and lock it again.

A hydraulically (or electrically) operated flap is available as an option. This is suitable for those that need to change the placing of the ejected snow while operating the equipment.



Mechanical flap control (Standard)



Hydraulic flap control (Option)

The ejector tube has two mounting holes. These will enable you to regulate the distance the ejected snow is thrown.

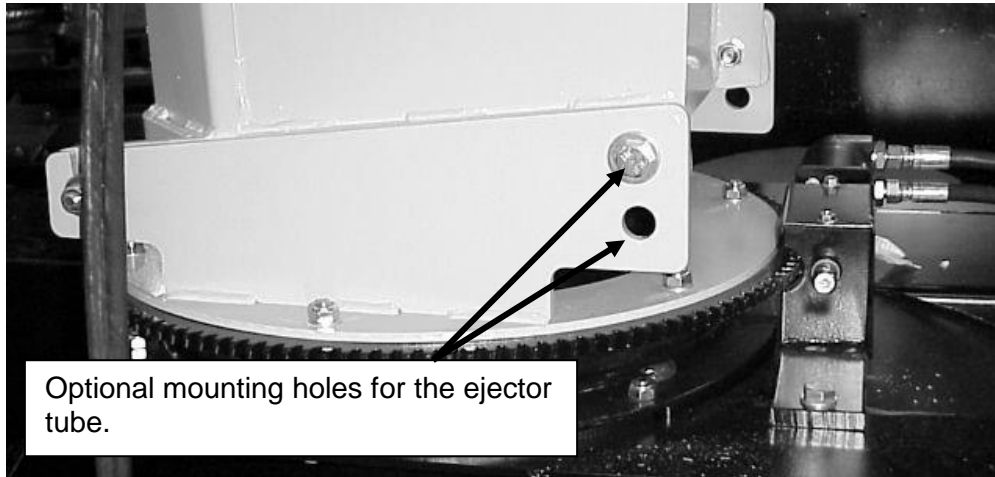

Supporting wheels

Supporting wheels are an optional extra. These will reduce the wear on the wearing edge and the supporting pads when clearing snow on surfaces like asphalt and concrete. The wheels carry the equipment and are to be adjusted so that the wear on the wearing edge is reduced.



3.5 Operating the machine



Warning!

Operator must have a good view over the working area and the area where the ejected snow lands. Heavy items in the snow, such as stones etc., can be propelled much further than the snow itself.

Before leaving tractors cabin ensure that all moving parts have come to a complete stop.

**Caution!**

The shear bolt is **No guarantee for machine not being damaged at impact with heavy, solid objects.**

To avoid damages on machine, lift snow blower before going backwards with the equipment.

A doubled driving speed, make the stress at the equipment four times higher. Damages on snow blower caused by impact with heavy, solid objects isn't covered by the warranty.

Keep the specified PTO 540 / 1000 rpm's all through the run. Try to keep the line of the PTO shaft as straight as possible when running the equipment. A standard PTO shaft must not operate at angles exceeding 35 degrees.

We advise you against using this equipment as a plough. Always let the equipment work its way through the snow with the cutter turning. When clearing great masses of snow you should work yourself through in two runs.

When operating in wet and heavy snow, more power is needed, and the equipment needs to be used with high revs before working on the snow. If you should come to a halt, stop the tractor, lift up the equipment, back up a bit, let the equipment down, and try again. Should there be an obstruction in the ejector tube, the tractor and the PTO must be stopped before the equipment is cleaned. Inform anybody in the vicinity that work is going on with the equipment. Drop the ejector tube and clear the obstruction.

When using the equipment for the first time in the cold season, you should set it to lean back a little. This will ensure that the wearing edge does not pick up a lot of stones and debris that can be ejected dangerously. After a while as the road has become hard, you can set the equipment to a more aggressive angle.

Reversing and front mounted

If the snow blower is mounted in the front of the tractor or at the rear of a reverse drive tractor the snow blower should to be equipped with a protective bow in the front. The bow is available as optional equipment. Fit the shear bolt clutch side of the PTO-shaft facing the tractor (A wrongly mounted PTO shaft can result in a breakage of the drive shafts).

4 Service and maintenance



Warning!

At any time when performing repairs and maintenance, the engine must be switched off and the PTO shaft disconnected. Withdraw the ignition key from the switch.

No work is allowed unless the equipment is safely secured. Always use protective equipment such as goggles and gloves when carrying out maintenance.

Do not use your fingers when examining little openings. This is to avoid accidents.

It is important to replace worn and damaged protection items in good time (e.g. protective shields).

To avoid injury to other persons, make sure that nobody is in the proximity.

4.1 General

Carefully maintain the equipment in order to achieve cost effectiveness and a long working life, prevent early repairs and keeping the value of the equipment. Use only quality lubricants and suitable tools. Do not use high pressure cleaning for the bearings and the hydraulic components. After cleaning the equipment, lubricate it according to the lubrication chart, and give it a brief test run.

Use the table below for the correct torque settings for the screws and bolts of the equipment.

Table 1 - Torque settings

Diameter	Class 8.8		Class 10.9	
	Nm	lb.ft.	Nm	lb.ft.
M8	25	18	35	26
M10	50	37	70	52
M12	90	66	125	92
M14	140	103	200	148
M16	215	155	305	225
M18	295	217	420	309
M20	420	302	590	438

When a locking nut is used, increase torque by 5%.

4.2 Maintenance schedule

Position	Interval	Type	Number	Note
PTO shaft Universal joint	8 h	Grease	2 pieces	NLGI2 EP
PTO shaft Profiled tubes	8 h	Grease	1 piece	NLGI2 EP, separate the two halves of the shaft and grease the tubes.
PTO shaft Shear bolt clutch	8 h	Grease	1 piece	NLGI2 EP
PTO shaft Plastic protections	8 h	Grease/oil	2 pieces	NLGI2 EP/10w30
All screws and bolts	8 h	Check	The whole equipment	Check that all screws and bolts are properly tightened and not loose.
Wearing edge	Daily	Check	1 piece	Check the wearing edge for wear. Turn over or replace as needed.
Cross shaft	40 h	Grease	1 piece	NLGI2 EP
Shear bolt clutch	40 h	Grease	2 pieces	NLGI2 EP
Feeding auger	40 h	Grease	2 pieces/screw	NLGI2 EP
Support bearing	40 h	Grease	1 piece	NLGI2 EP
Transmission chain	40 h	Oil	1 piece	Engine oil 10W40
Turntable gear	40 h	Grease	2 pieces	NLGI2 EP
Chain tensioner	40 h	Adjustment	1 piece	Check the tension. You should be able to push the chain down about 7mm (9/32") The feeder screw should run smoothly without any noise from the chain.
Gearbox	40 h	Check	1 st	Visually check of the oil level, the oil should reach the lower level plug. Fill Oil if needed. SAE 80W/90 API GL4/GL5, Industrial gear oil ISO VG 220
Gearbox	First 50 h	Oilchange		Oil SAE 80W/90 API GL4/GL5, ISO VG 220
Gearbox	500 h / yearly	Oilchange		Oil SAE 80W/90 API GL4/GL5, ISO VG 220

When lubricating use low temperature grease. These intervals are to be used for normal usage. Always lubricate after cleaning with water.

4.3 Before the snowy season

All the above points (chapter 4: Service and maintenance) are to be done. Equipment well serviced lasts longer.

4.4 After the snowy season

After the season, the equipment must be thoroughly cleaned, and then greased and serviced. When the machine is dry, we suggest that you cover the parts where the paint has worn away with a thin coating of oil. Store the snow blower in a dry storage.

4.5 Gearbox oil check and change

Check oil level with cold gear box and level machine. Oil level should reach the lower part of the glass. If necessary add recommended oil through the breather on the top of the gear box.

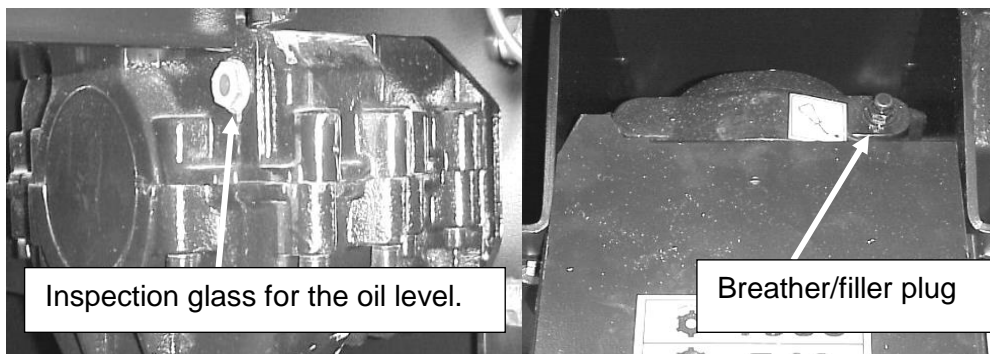

Oil change

The oil in the gearbox must be changed after the first 50 hours of service and then again every 500 hours or at least once a year.

Start the PTO and run the equipment until the gearbox oil is warm. Unscrew the filler plug on top of the gearbox. Open the drain plug and drain the oil into a suitable container. Clean the plug and reinstall it. Refill with correct grade oil until the oil reaches the lower part of glass at the side of the gear box. **After filling, allow the oil to penetrate the gears and bearings before checking the correct level.** When the oil level is correct, reinstall the filler plug and wipe away any spills.

Oil: SAE 80W/90 API GL4/GL5, Industrial gear oil ISO VG 220

Volume: 4 Litres.

NOTE! Dispose of the old oil in an environmentally correct manner and according to the laws of your country!

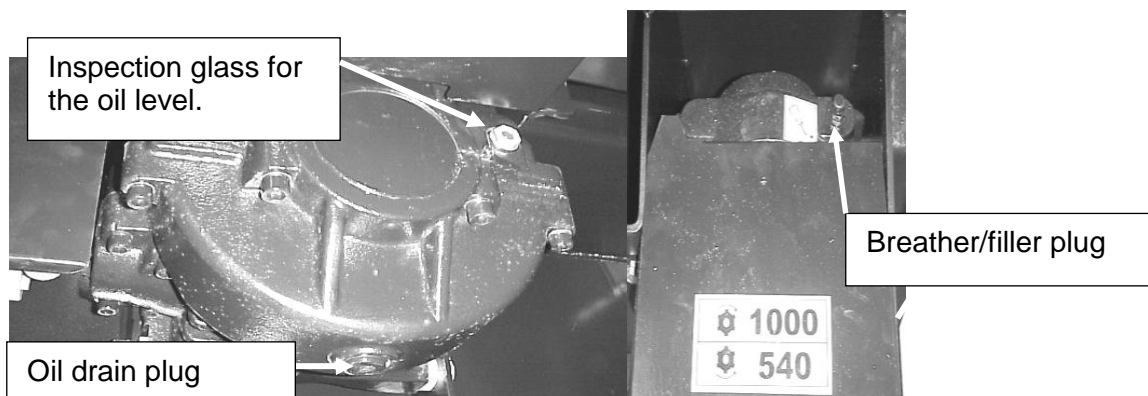

5 Troubleshooting



Warning!

Before any maintenance, service, repairs or adjustments are carried out, the equipment must be lowered to the ground and the engine of the tractor must be stopped. The key must be removed from the starter switch.

Problem	Probable cause	Action
Rotor and feeder screw do not turn.	Shear bolt on PTO-shaft is broken.	Change bolt M12x60 8,8 . NOTE! Do not use a bolt that is threaded all the way.
Feeder screw does not turn.	Shear bolt is broken.	Change bolt M10x60 8,8 . NOTE! Do not use a bolt that is threaded all the way.
The shear bolt on the PTO shaft often breaks.	Rpm's are too low. Load is too high. Vibrations from the PTO shaft. The power train is subject to chock loads.	Always maintain 540 or 1000 rpm at the PTO. Lessen the work load. Work the snow twice. The angle of the universal joints is too large. Check the shaft. Avoid chock loads.
There are often stoppages.	Wet snow. Frozen snow in the frame. Speed is too high. The gap between the wear blade and the surface is too large.	Increase rpm's. Clean. Decrease the speed. Decrease the gap.
There is snow left on the surface.	Supporting pads are set too high. The equipment is leaning backwards. The wearing edge is worn.	Adjust the height. Adjust the angle. Turn it over or replace it.

Spare shear bolts are found in the toolbox.

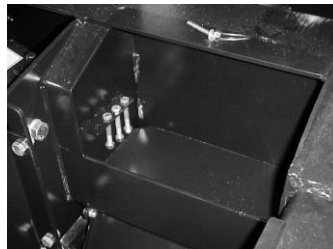

Shear bolt for the feeder screw M10x60 **8,8**



Shear bolt on PTO shaft M12x60 **8,8**

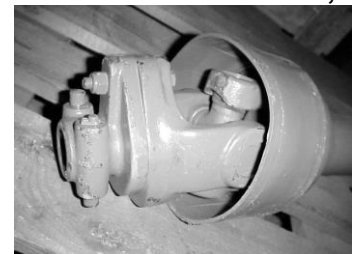

6 Spare Parts

Your choice is between “original” or “copies”!

Price is often the deciding factor. A “cheap” choice may well be an expensive one in the end.

Some reasons to choose TREJON spare parts:

The guarantee does not cover arbitrary changes made on the equipment.

- Quality and fit.
- Reliability
- Longer service life and therefore better economics
- Guaranteed availability through the TREJON sales partners

The TREJON original spare parts are specifically made for this equipment. The fitting and/or use of non-original parts and accessories may change the technical qualities of your equipment in a negative way. The manufacturer does not give any guarantee for damages caused by using non-original parts or accessories.



Contact the authorised dealer where you purchased the machine when you wish to order repair parts or need other assistance.

When you are ordering repair parts, make sure you know the model, type and serial number of the machine. See the plate on the chassis.



EC-Certificate of Conformity

conforming to EEC Directions 2006/42/EG

We **TREJON FÖRSÄLJNING AB**
 (name of supplier)

SE – 911 35 Vännäsby, Företagsvägen 9

 (full address of company – where this concerns authorized agents within the Common Market, also state the company name and manufacturer)

declare in sole responsibility, that the product

Snow blower OPTIMAL 2450HD
Snow blower OPTIMAL 2452HD

 (make, model)

to which this certificate applies, conforms to the basic safety and health requirements of EEC Directions 2006/42/EG,
 (if applicable)
 and to the other relevant EEC Directions.

— — —

 (title and/or number and date of issue of the other EEC Directions)

(if applicable)
 To effect correct application of the safety and health requirements stated in the EEC Directions, the following standards and/or technical specifications were consulted:

EN ISO 12100-1 : 2003 EN ISO 12100-2 : 2003

 (title and/or number and date of issue of standards and/or specifications)



Håkan Johansson
Managing Director

Vännäsby, 01.01.2009

 (Place and date of issue)

.....
 (Name and job function of authorized person)



TREJON AB
Företagsvägen 9
SE – 911 35 Vännäsby

Garantie- / Übergabeerklärung

- | | |
|-----------------------------|--|
| Garantiebedingungen | - Geltend zwischen der Verkaufsstelle (Vertriebspartner von Trejon AB) und dem Maschinenkäufer. |
| Allgemeines über Garantie | - Um Garantieleistungen zu erhalten, gelten die unten angegebenen Bedingungen sowie die vom jeweiligen Lieferanten gestellten spezifischen Garantiebedingungen. Diese sind im vorkommenden Fall dem Handbuch für das jeweilige Gerät zu entnehmen. |
| Die Gültigkeit der Garantie | - Die Garantie gilt 12 Monate vom Kaufdatum. |
| Die Garantie ersetzt | - In bestimmten Fällen, kann die Garantie durch die Betriebszeit begrenzt sein. |
| | - Beschädigte Teile, deren Defekt bei <u>normaler</u> Anwendung aufgrund von Herstellungs- oder Rohstofffehler entstanden sind. |
| Die Garantie ersetzt nicht | - Nur die Arbeitskosten beim Austauschen beschädigter Garantieteile. |
| | - Die Frachtkosten für die Maschine oder Teile. |
| | - Reisekosten. |
| | - Evtl. entstehende Folgekosten aufgrund eines Maschinenschadens. |
| | - Ein Gerät, das vom Käufer selbst hergestellt wurde / an dem er Änderungen hat vornehmen lassen. |
| | - Schäden, die auf normalen Verschleiß (nicht bezogen auf Herstellungsfehler), mangelhafte Wartung, die Unerfahrenheit des Benutzers oder Benutzung von nicht originalen Ersatzteilen zurückzuführen sind. |
| | - Unüblicher oder ungeeigneter Gebrauch der Maschine. |
| | - Verschleißteile, wie Schläuche, Dichtungen, Öle, Batterien, Riemen, Klingen usw. Die Garantiezeit für ausgetauschte Teile erlischt gleichzeitig mit der der Maschine. |
| Verfahren | - Normale Justierungen, Pflege, Wartung oder Anleitung. |
| | - Nehmen Sie sobald eine Beschädigung oder eine Fehlfunktion entdeckt wird Kontakt mit Ihrer Einkaufsstelle auf. |
| | - Benutzen Sie die Maschine nicht, falls die Beschädigung dadurch verstärkt werden kann. Garantiereparaturen dürfen nur durch eine von Trejon AB angeerkante Werkstatt ausgeführt werden. |

ACHTUNG! Die Garantie tritt unter den Voraussetzungen in Kraft; dass die **GARANTIE-/ÜBERGABEERKLÄRUNG** der Maschine vollständig ausgefüllt und von beiden Parteien (Verkäufer und Käufer) unterschrieben ist (diese wird beim Verkäufer archiviert); und dass die Übergabe innerhalb von 14 Tagen nach Übergabedatum auf trejon.se registriert wurde (der Verkäufer ist dafür verantwortlich).

Übergabeerklärung:

Der Käufer der Maschine bestätigt mit seiner Unterschrift, dass er das Handbuch mit Betriebsanweisungen erhalten hat, sowie dass er über die erforderlichen Bedienung-, Sicherheits- und Wartungsinstruktionen des Handbuches informiert wurde und eine Übergabekontrolle durchgeführt hat.

BITTE IN DRUCKSCHRIFT!



Produkt: _____	Serien Nr.: _____
Verkäufer: _____	Firma: _____
Unterschrift Verkäufer: _____	Kaufdatum: _____
Name des Käufers: _____	Telefon: _____
Email: _____	
Adresse: _____	PLZ: _____
Ort: _____	Land: _____
Ort & Datum: _____	Unterschrift des Käufers: _____

TREJON AB reserves the right to change or to improve shown models using technical or commercial reasons, without demands to carry out the same improvements on equipment already delivered. Pictures in the manual do not necessarily show the equipment as delivered.

Technical data, weights and measures are without obligation. Reservation for faults.

© 2017 Trejon AB, Sweden

Copying, translation and excerpts are only permitted with a written permit from TREJON AB, Företagsvägen 9, SE – 911 35 Vännäsby.

All rights reserved.



TREJON FÖRSÄLJNINGS AB

Företagsvägen 9

SE-911 35 VÄNNÄSBY

SWEDEN

Tel: + 46 (0)935 39 900

Webb: trejon.se